

WEBB DECO Lighting Specification

灯具技术规格书

www.webbdecolighting.com

产品型号:

10.0718



基本参数:

- 材质: 灯体: 304#不锈钢面盖, ADC12压铸铝合金及6063挤压铝合金
反射器: 99.99%高纯度阳极氧化铝
出光玻璃: 15mm强化安全玻璃
密封圈: 耐老化耐水蒸气胶圈
紧固件: 304#不锈钢螺丝
- 表面处理: DuPont2层氟碳喷涂或环氧聚酯粉喷涂
- 输入电压: AC220V 50Hz;
- 光源寿命: ≥9000小时;
- 防护等级: IP67, I类绝缘,
- 引出线: 灯具出线1.1m, 3×1mm² 电缆线
- 环境温度: (-30℃, +45℃)
- 内箱尺寸:
- 外箱尺寸:

灯具尺寸图:

A: 一体式尺寸图

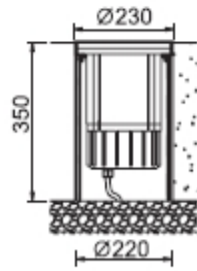

B: 分体式尺寸图

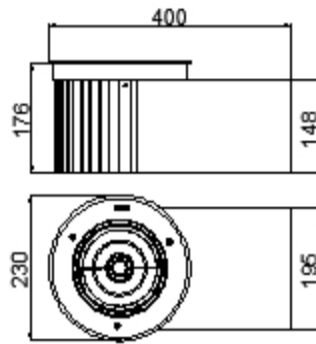

配光曲线图:

10.0718.1S

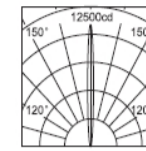

H(m)	medlux	maxlux
2.00	2340	3000
5.00	360	480
10.00	90	120
15.00	40	53

10.0718.2S

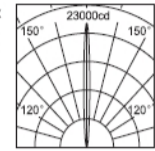

H(m)	medlux	maxlux
2.00	4875	5625
5.00	725	900
10.00	182	225
15.00	67	88

10.0718.1M

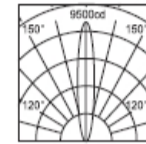

H(m)	medlux	maxlux
2.00	1740	2250
5.00	278	360
10.00	70	90
15.00	31	40

10.0718.2M

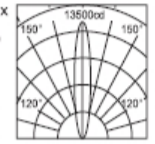

H(m)	medlux	maxlux
2.00	2150	2580
5.00	344	413
10.00	86	103
15.00	38	46

10.0718.4M

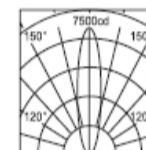

H(m)	medlux	maxlux
2.00	1450	1850
5.00	232	296
10.00	58	74
15.00	26	33

10.0718.1F

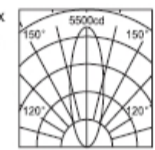

H(m)	medlux	maxlux
2.00	900	1650
5.00	188	240
10.00	52	50
15.00	22	32

10.0718.2F



H(m)	medlux	maxlux
2.00	1625	2025
5.00	260	324
10.00	65	81
15.00	29	36

灯具技术规格书

www.webbdecolighting.com

产品型号说明:

10	0718	*	*
灯具种类	模具型号	光源代码	光束角
10: 埋地灯		1: HIT 35W-G12 2: HIT 70W-G12 4: HST 70W-E27	S: 窄角5-10° M: 中角15-25° F: 宽角30-50° W: 超宽60-100°

灯具参数:

产品型号	光源	色温	灯头	光束角	光通量	灯具重量	包装毛重	图号
10.0718.1S	HIT 35W	3000K/4200K	G12	5°	3300lm	8.1kg		A/B
10.0718.2S	HIT 70W	3000K/4200K	G12	5°	6600lm	8.6kg		A/B
10.0718.1M	HIT 35W	3000K/4200K	G12	15°	3300lm	8.1kg		A/B
10.0718.2M	HIT 70W	3000K/4200K	G12	15°	6600lm	8.6kg		A/B
10.0718.4M	HST 70W	2000K	E27	20°	5600lm	8.6kg		A/B
10.0718.1F	HIT 35W	3000K/4200K	G12	30°	3300lm	8.1kg		A/B
10.0718.2F	HIT 70W	3000K/4200K	G12	30°	6600lm	8.6kg		A/B

可选配件:

防眩光格栅

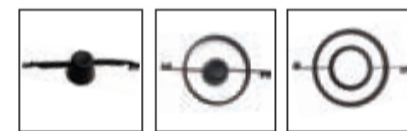

90.1011 90.1021 90.2022

彩色镀膜玻璃



92.1021 92.1022 92.1023 92.1024 92.1025

方形面盖



96.0718

光学玻璃

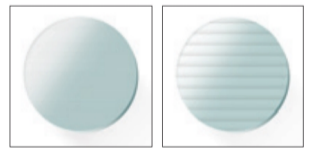

91.1021 91.1022